

# Christopher Columbus Facts

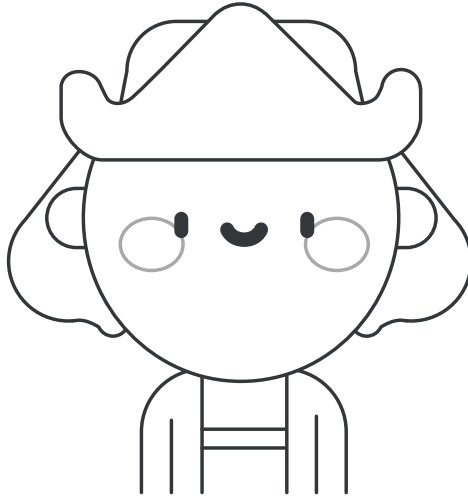

## 10 Fun Facts About Christopher Columbus!

Christopher Columbus was an Italian explorer and navigator born in between 25 August and 31 October 1451 and died on 20 May 1506.



His Italian name was Cristoforo Colombo and he was born in the Republic of Genoa, now Italy.

He completed four voyages across the Atlantic Ocean with the intention of going to East Asia, however, he ended up arriving in the "New World", the Americas.

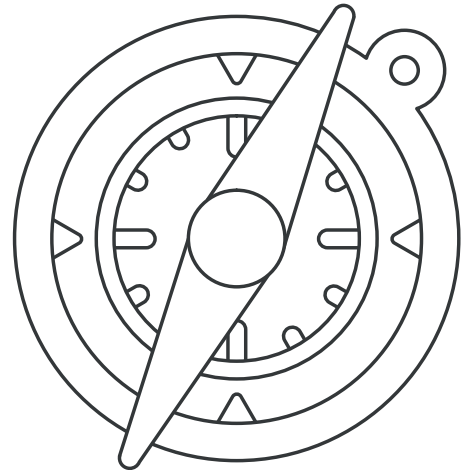

The three ships used by explorer Christopher Columbus on his first trip were La Niña, La Pinta, and La Santa Maria.

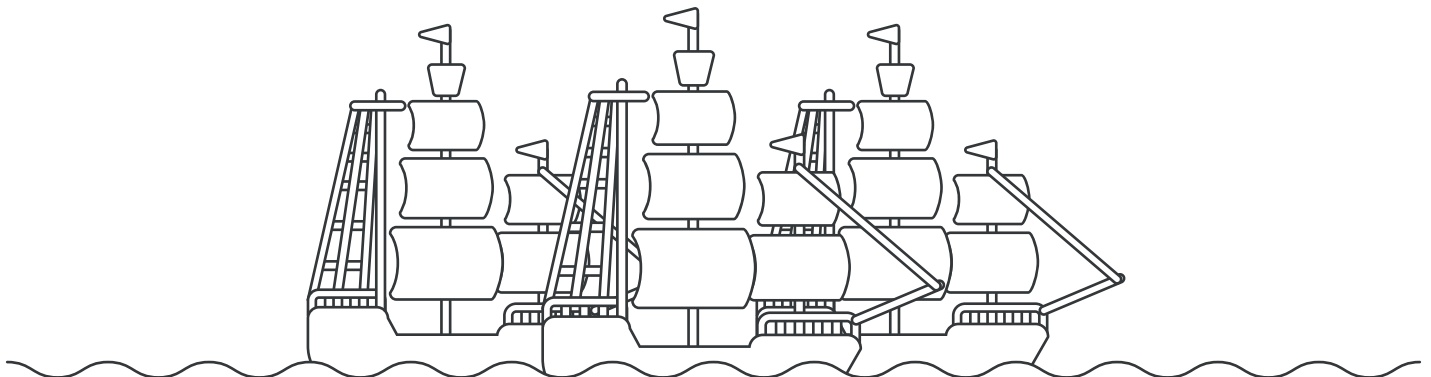

# Christopher Columbus Facts



## 10 Fun Facts About Christopher Columbus!

His first voyage set sail on August 3, 1492, from Spain to find a sea route to Asia was on August 3, 1492. Two months later, he landed on a small island in the Bahamas and he called it San Salvador.

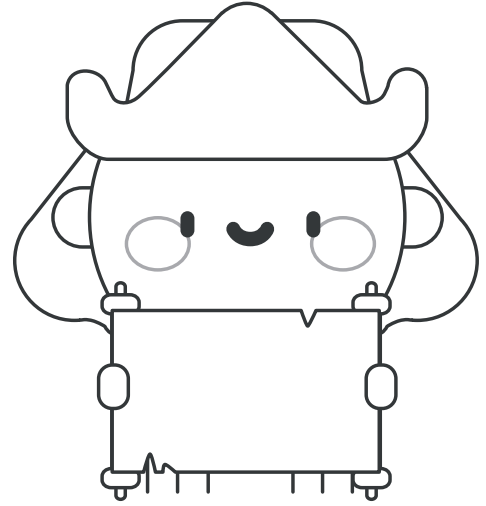

The second voyage was in 1493, where he sailed with 17 ships and about 1200 men, arriving in Hispaniola, the most populous Caribbean island, in late November.

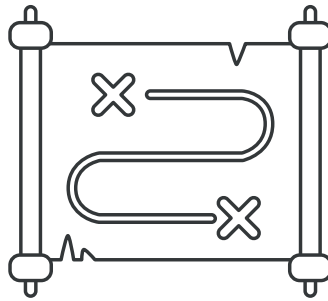

His third voyage in 1498 took him to Trinidad and within reach of the South American mainland.



On his fourth voyage, on March 14, 1502, his goal was to find the Strait of Malacca to the Indian Ocean. He explored Honduras, Nicaragua, Costa Rica, and Panama.

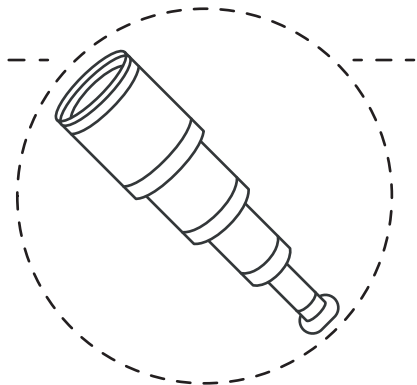

He was sponsored by the Spanish crown, Queen Isabella and King Ferdinand, opening the way for the widespread European exploration and European colonization of the Americas.

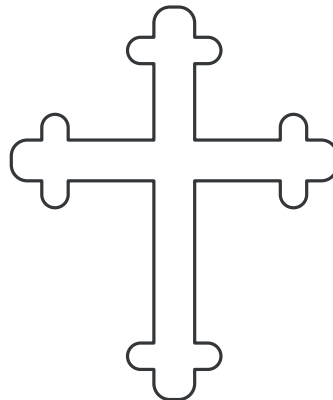
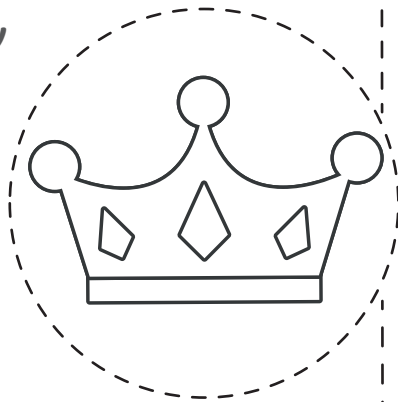

Following his death in 1506, Columbus was buried in Valladolid, Spain, and then moved to Seville. However, his body was shipped across the Atlantic Ocean to Hispaniola and interred in a Santo Domingo cathedral.