

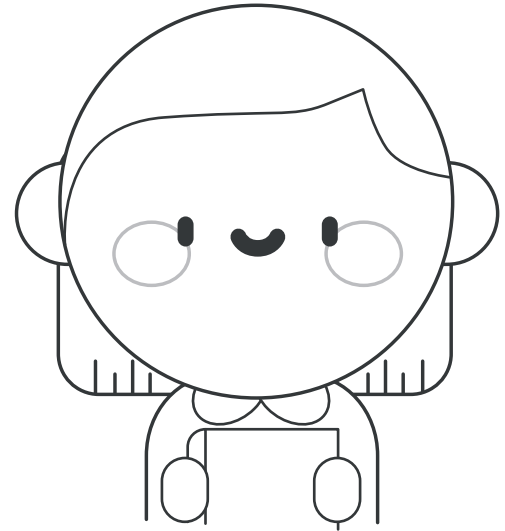

Anne Frank Facts

10 Fun Facts About Anne Frank!

Annelies Marie Frank was a German-born Jewish girl who kept a diary in which she documented life in hiding under Nazi persecution during World War II.



Anne Frank was born June 12, 1929, in Frankfurt, Germany, and died in 1945 in Bergen-Belsen concentration camp in Germany.

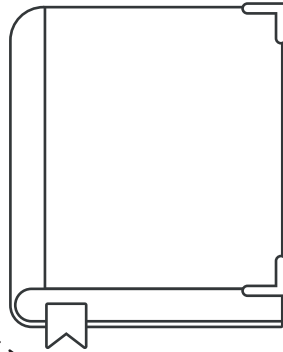
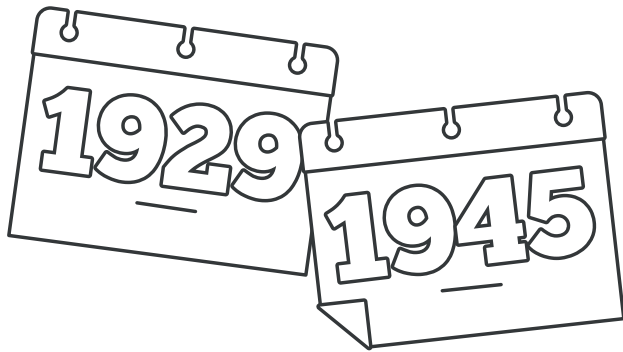

Anne's Diary, known internationally as the Diary of Anne Frank or The Diary of a Young Girl, became popular because it recounted the life hidden from the outside world.

Anne's family, the Van Pels family, and Fritz Pfeffer went into hiding in the secret annex located behind Otto Frank's office building in Amsterdam, Netherlands. There were 8 people living together.

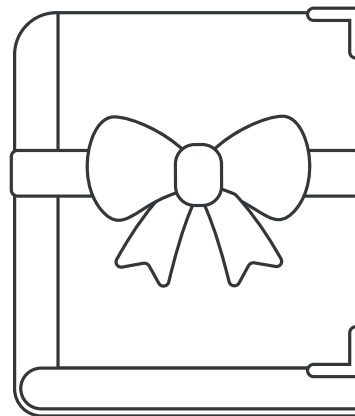
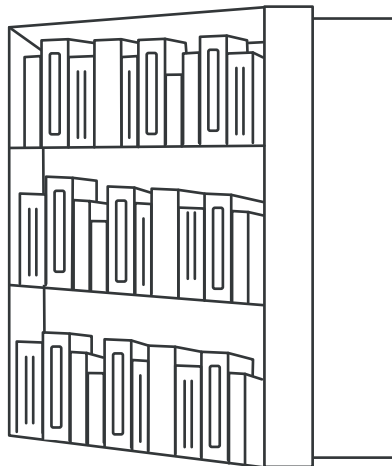

Anne Frank celebrated her 13th birthday on June 12, 1942, while in hiding in the secret annex. As a gift, her parents gave her a red checkered diary, which she later used to document her experiences.



Anne Frank Facts

10 Fun Facts About Anne Frank!

Otto Frank was Anne's father. He was the sole survivor of the family after their hiding place was discovered.

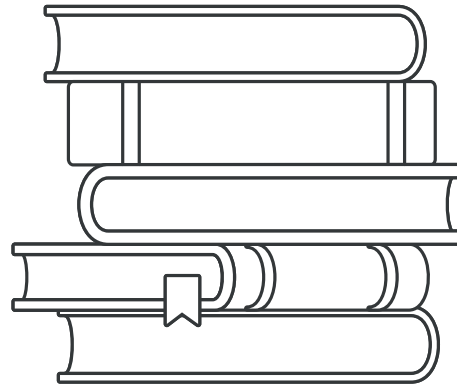
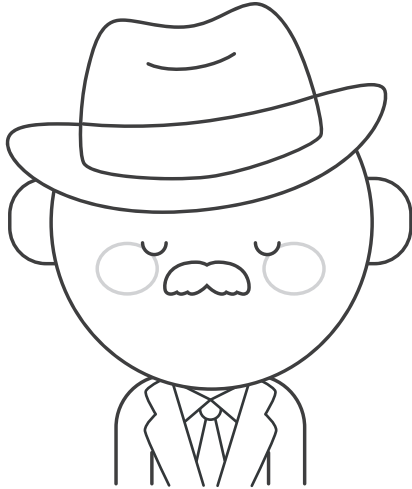

Otto later published his daughter's diary as she wanted to become a writer and planned to write a book about her experiences after the end of the war.

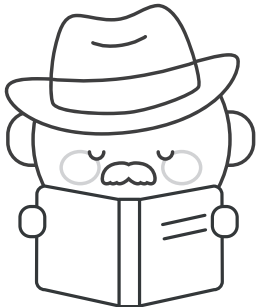

After reading Anne's diary, Otto said: "The Anne that appeared before me was very different from the daughter I had lost. I had no idea of the depth of her thoughts and feelings".

Johannes Kleiman and Victor Kugler were two of Otto Frank's trusted employees who helped prepare and maintain the hiding place. They played essential roles in ensuring the safety and well-being of those in hiding.



Anne Frank House, located in Amsterdam, is the actual building where the secret annex was concealed. It has been converted into a museum that provides insights into the lives of those in hiding and commemorates Anne Frank's legacy.

